



PHOTONICS RESEARCH GROUP

III-V/silicon photonics for microwave photonics

The case of an electro-photonic frequency converter

G. Roelkens¹, W. Bogaerts¹, D. Van Thourhout¹, G. Mortier¹, R. Baets¹, E. Bente², L. Thomassen³

¹ Photonics Research Group, Ghent University – imec

² Eindhoven University of Technology, Netherlands

³ Antwerp Space, Belgium



Outline

- Silicon photonics
- III-V/Silicon photonics
- Electro-photonic frequency converter as case for MWP applications

Silicon photonics

High index contrast waveguide structures

- Size reduction of photonic integrated circuits
- CMOS fabrication technology (200mm/300mm)
- High performance passive devices
- High performance Ge photodetectors
- High performance electro-optic devices

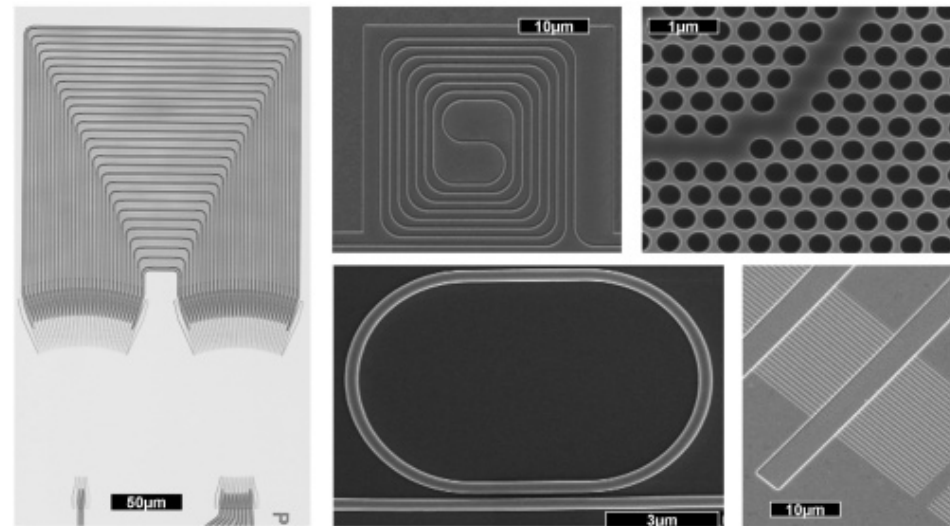
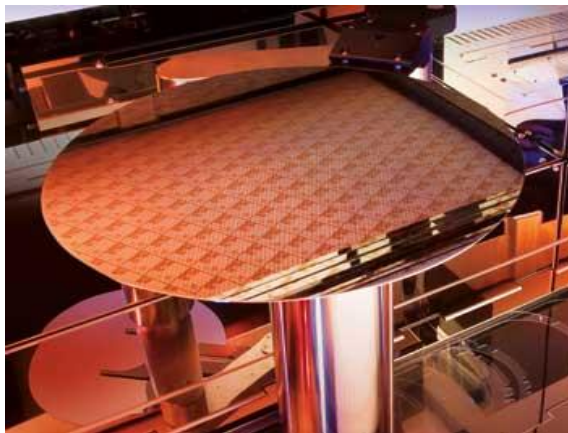
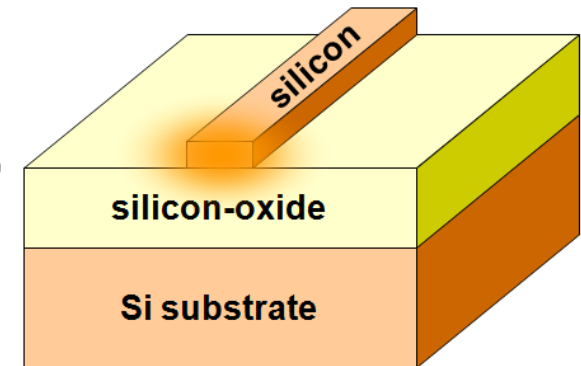

Silicon wire waveguides

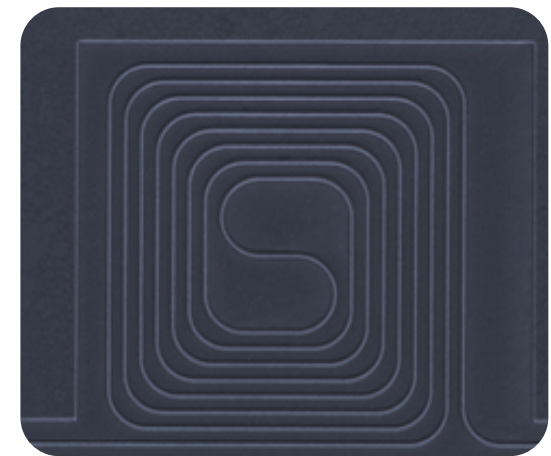
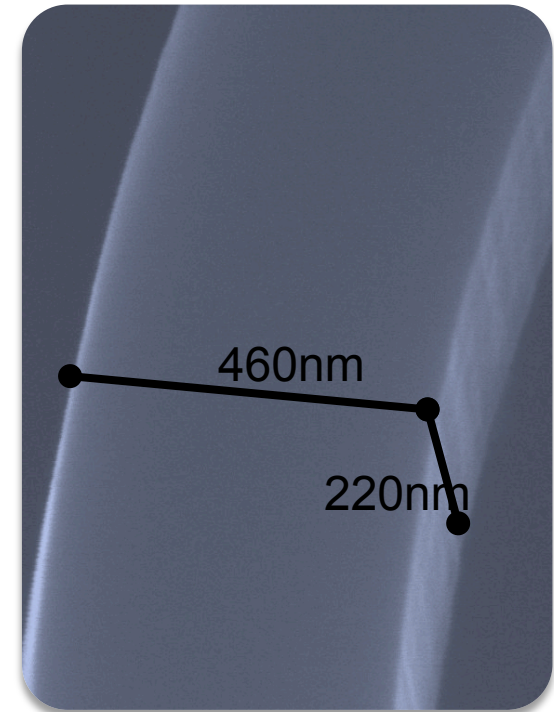
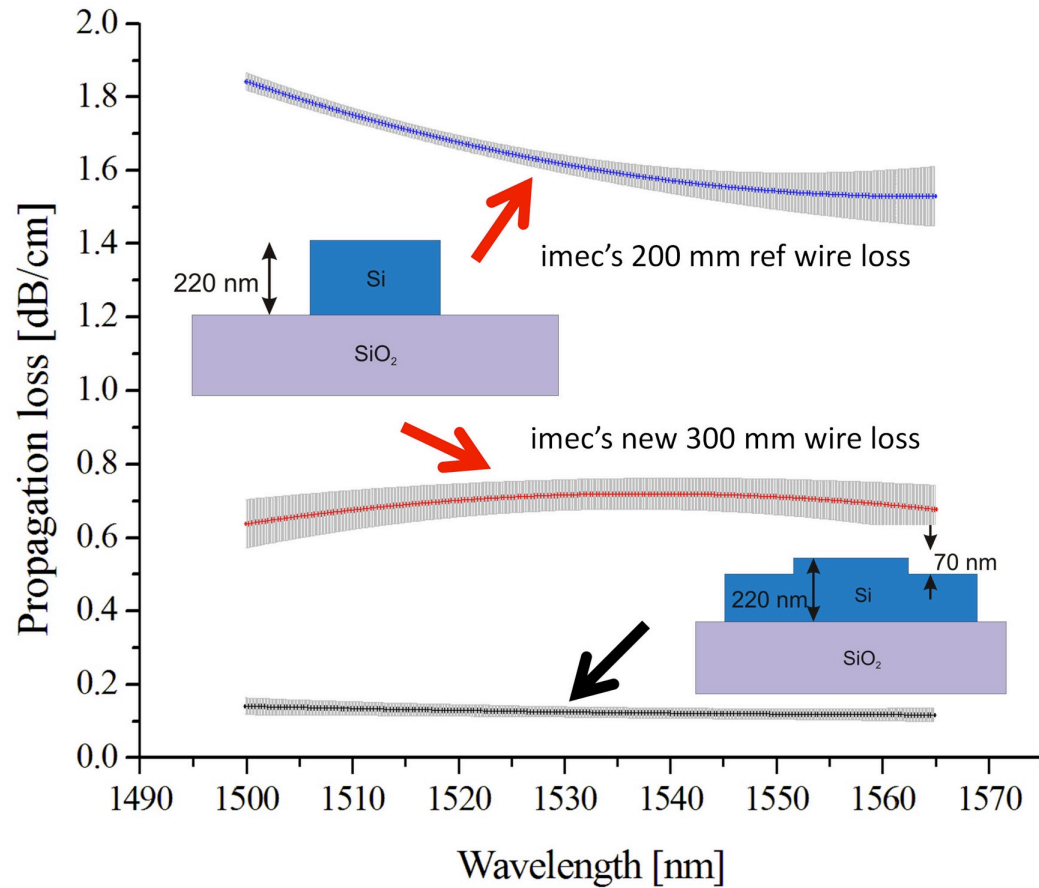

Spectral filters

Bragg reflectors

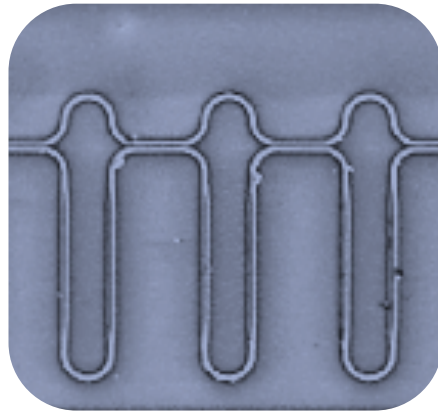
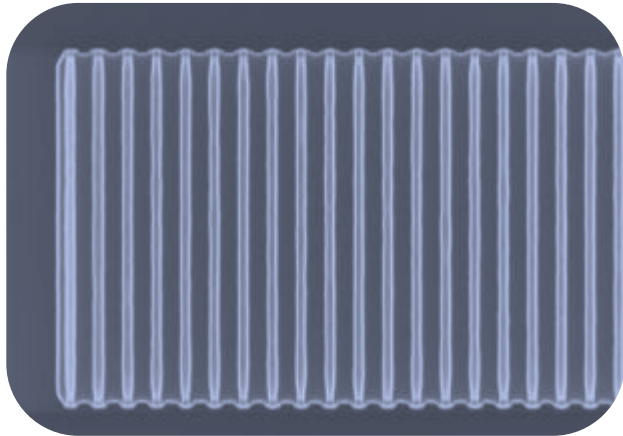

Mach-Zehnders

Ring resonators



Echelle gratings

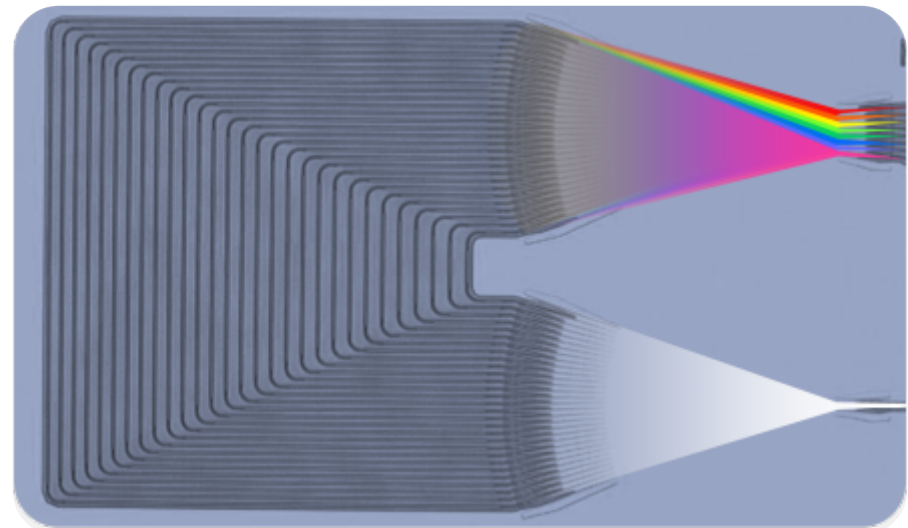
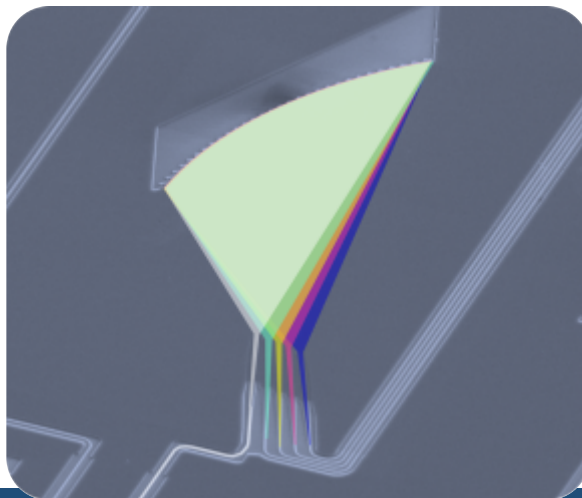

Arrayed waveguide gratings

Example: ring resonators with intrinsic Q of $8 \cdot 10^5$

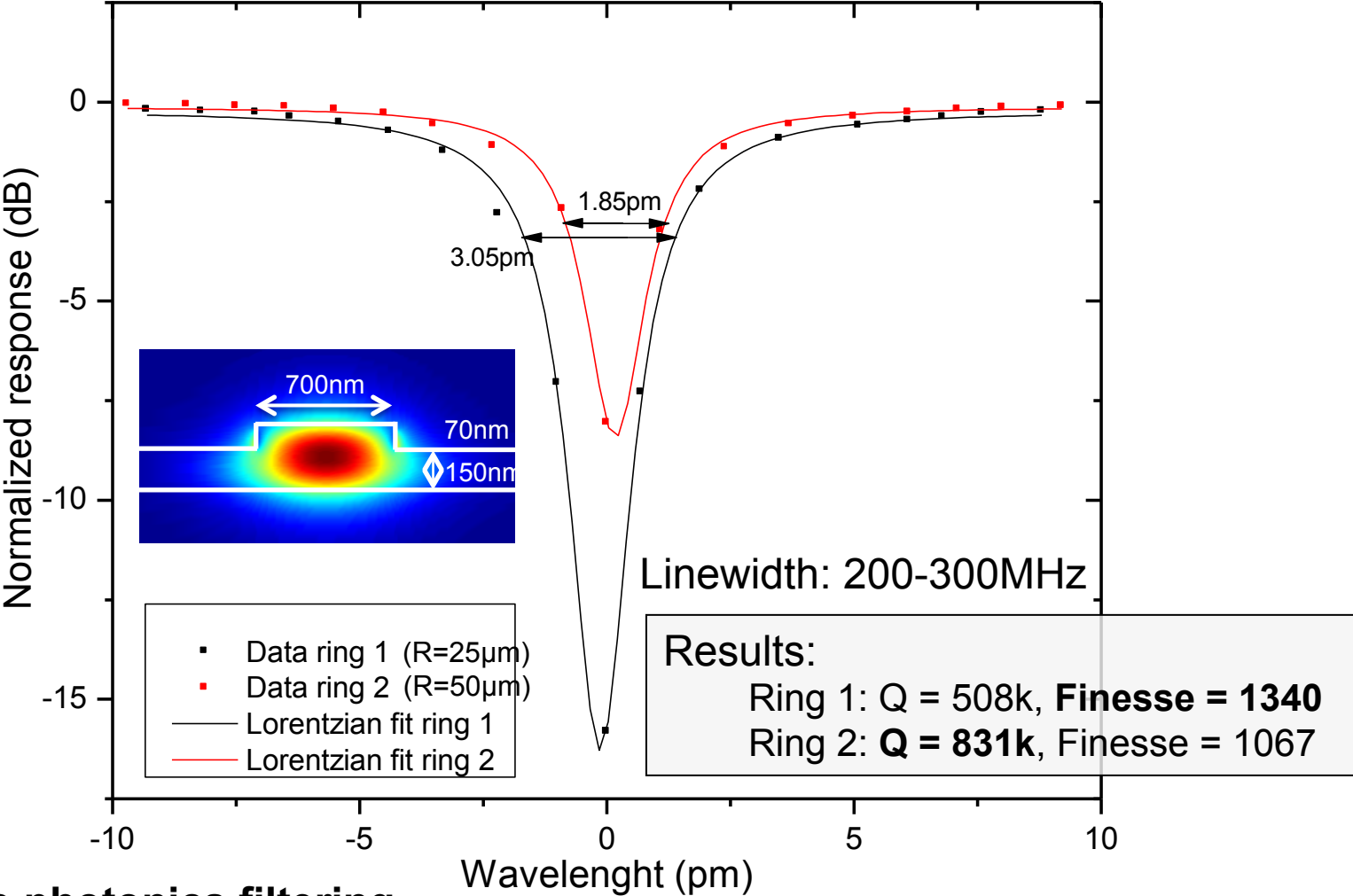

Microwave photonics filtering

High speed optical modulators

Based on carrier depletion in a lateral p-i-n diode => phase change

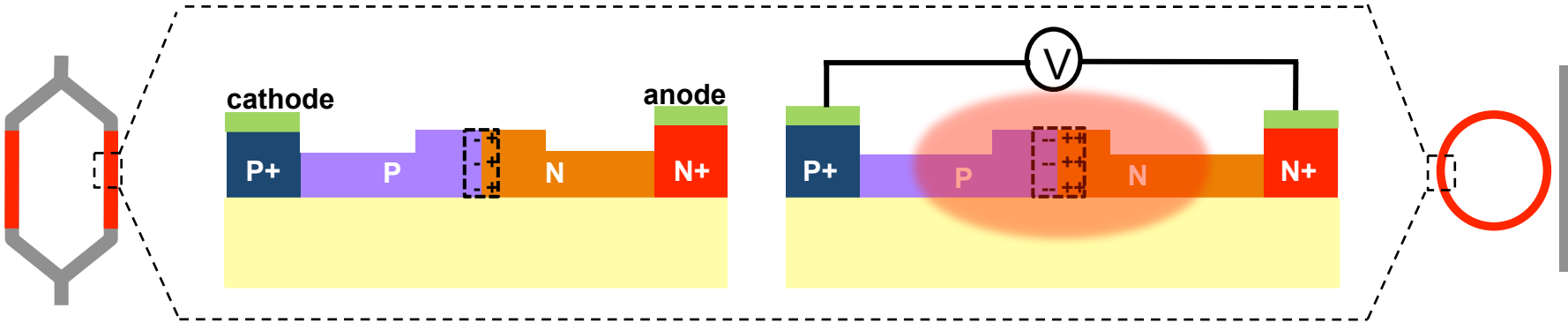

Doping patterns to enhance the modulation efficiency, linearity,...

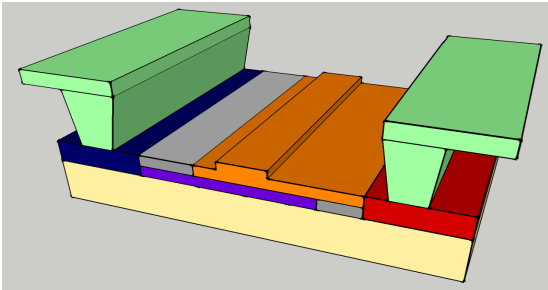

Vertical PN junction

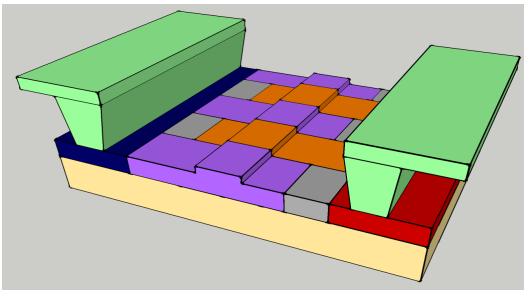

Interdigitated PN junction

High speed optical modulators

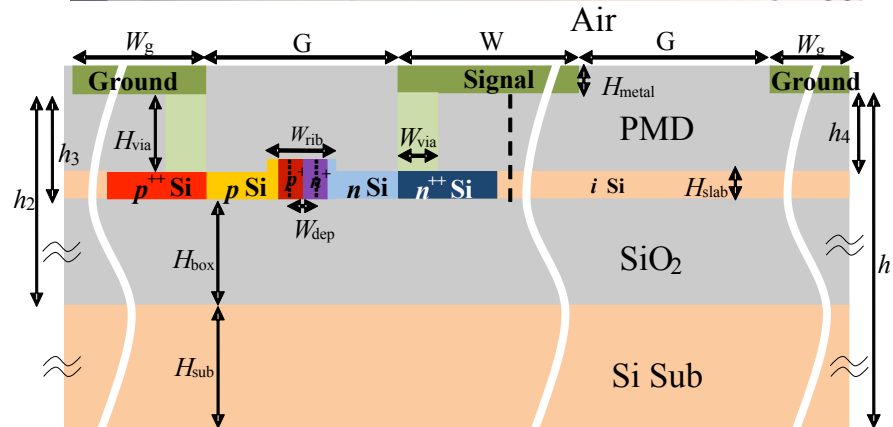
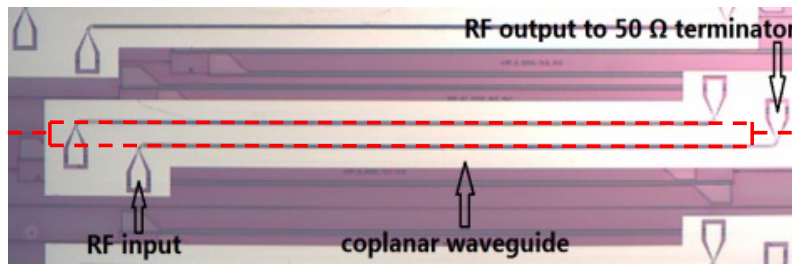

- conformal mapping
- partial capacitance technique

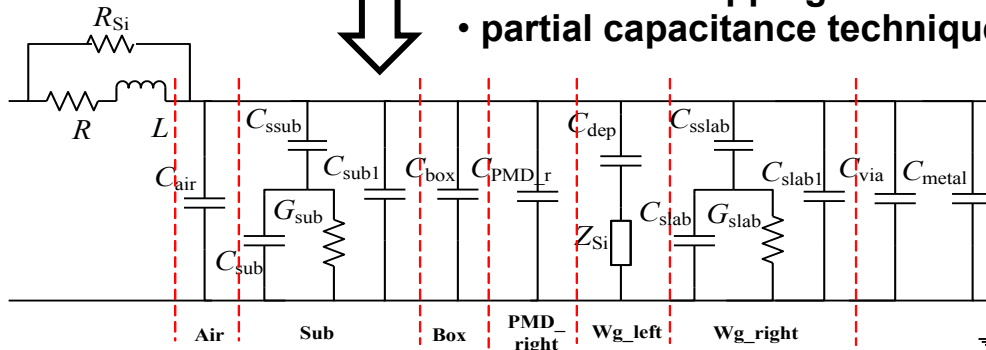

Bandwidth of the traveling wave design is determined by:

- impedance match;
- RF attenuation;
- velocity match between RF and lightwave.

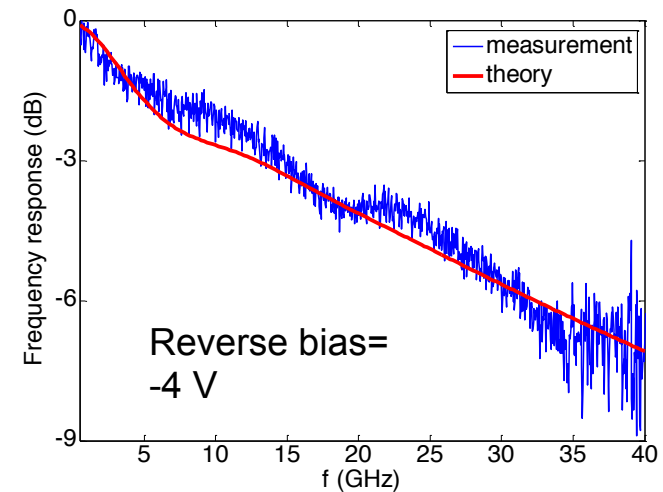

- f_{3dB} of $|S_{21}|$ is 15 GHz for 3 mm traveling wave electrode;
- f_{3dB} of $|S_{21}|$ is 5.5 GHz for 1.5 mm lumped electrode.

High speed optical modulators

- Currently most focus is on digital applications
- Literature on linear modulation in silicon is emerging [1] [2]

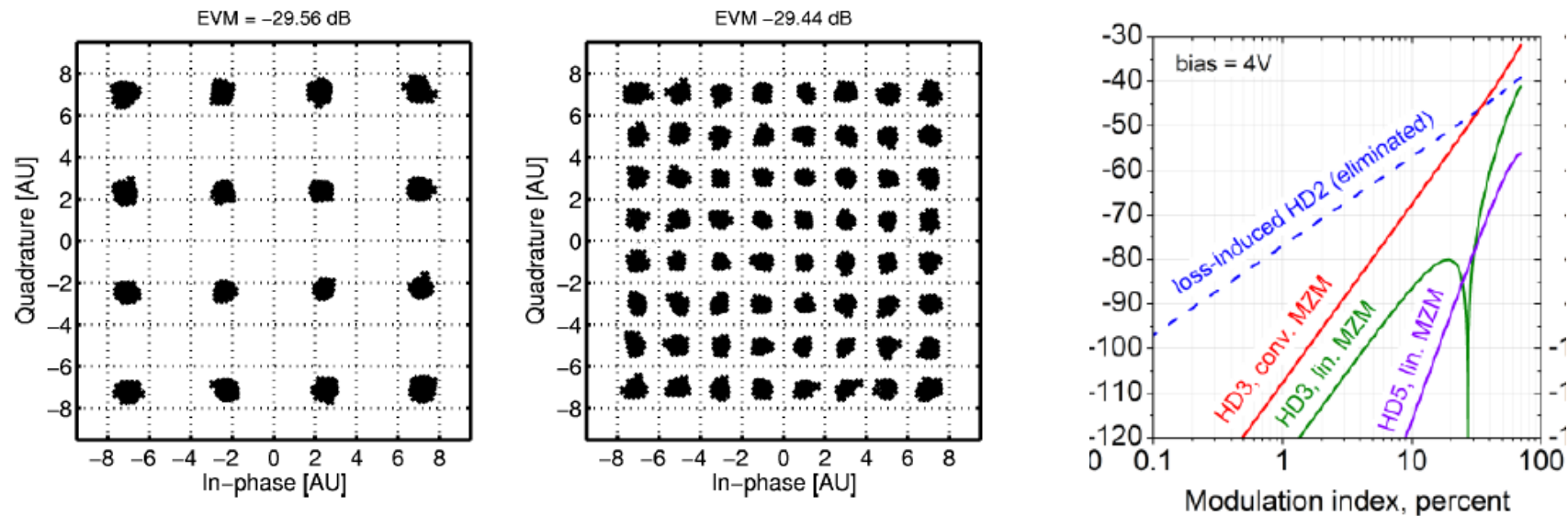

- [1] A Silicon modulator enabling RF over fiber for 802.11 OFDM signals, JSTQE 16(1), p. 141 (2010)
[2] Broadband linearized silicon modulator, Opt. Expr. 19(5), p. 4485 (2011) (figure b)

Ge photodetectors

Process is currently being developed in imec

- First results: 10Gbit/s operation
- 100GHz bandwidth in a single PD and 10Gb/s operation in a balanced configuration has been shown (process: CEA-LETI)

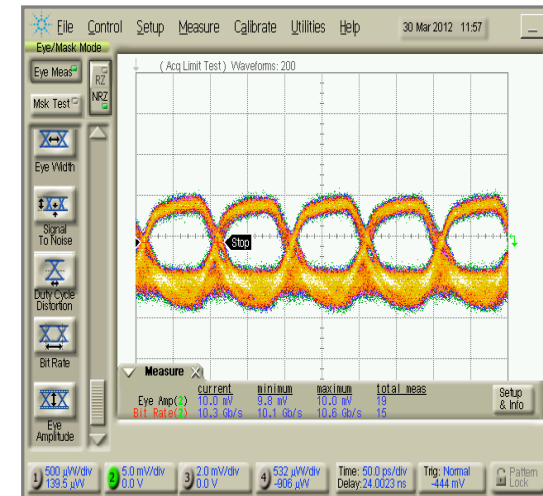

[1] Zero-bias 40Gbps Ge waveguide photodetector on Si Opt Expr 20(2), p.1096-1103

High-efficiency fiber-to-chip grating couplers

-1.6dB coupling efficiency

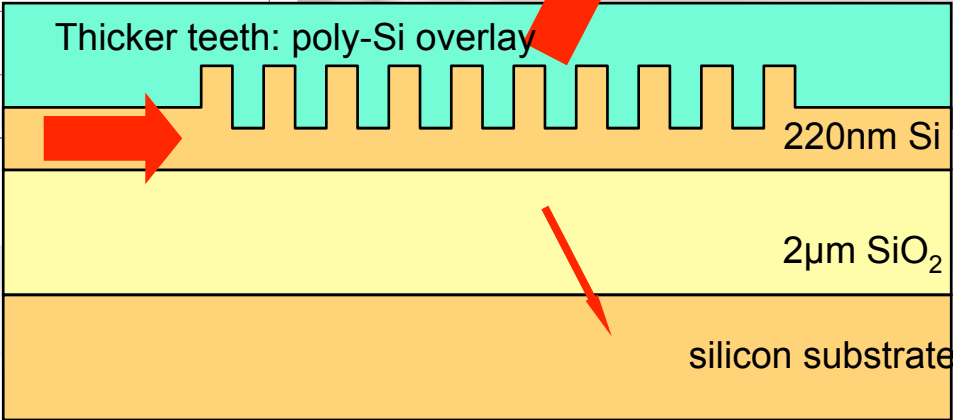
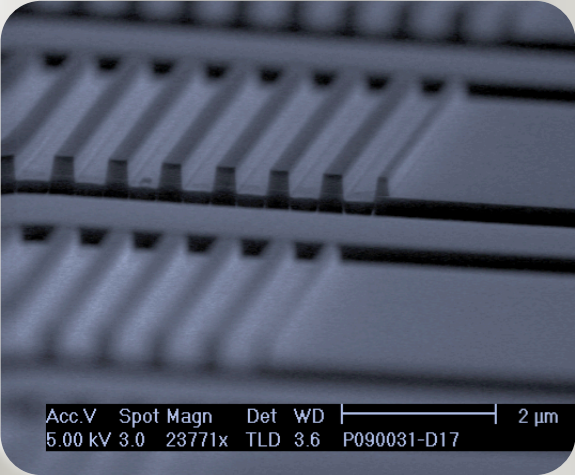
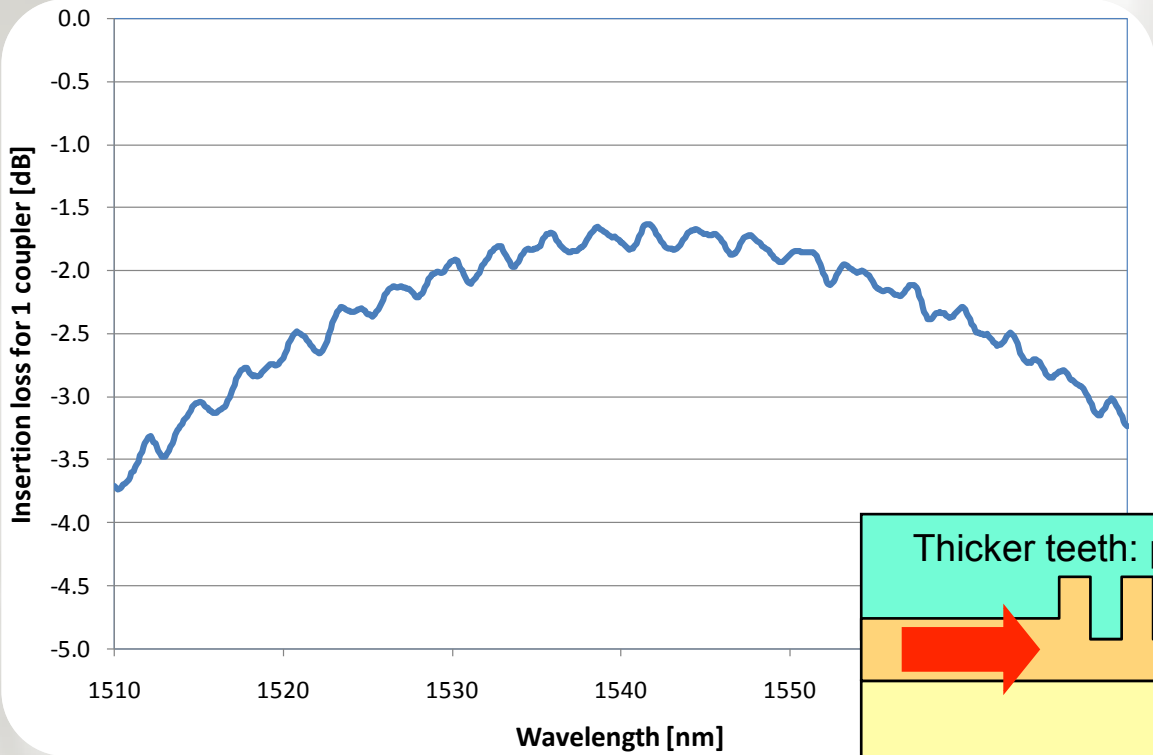

Automated wafer-scale measurement set-up



Grating couplers enable wafer-scale testing of the photonic integrated circuits

Outline

- Silicon photonics
- **III-V/Silicon photonics**
- Electro-photonic frequency converter as case for MWP applications

Silicon ++ photonics

Integration of light sources and optical amplifiers

- Completes the set of building blocks
- Heterogeneous integration of III-V semiconductors
 - state-of-the-art electrically injected light sources
 - Large design space and many technological choices

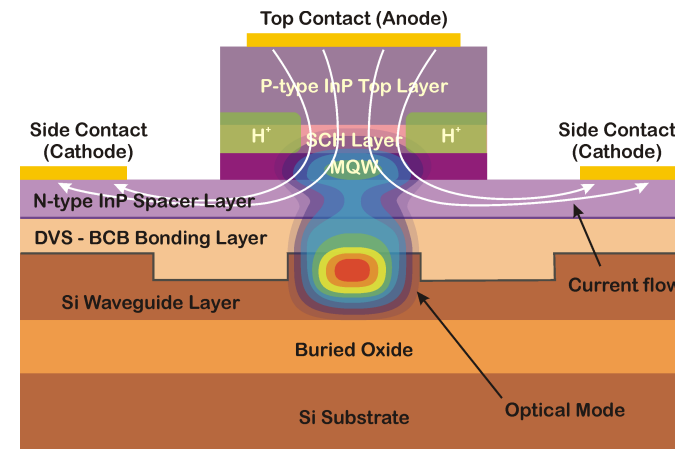
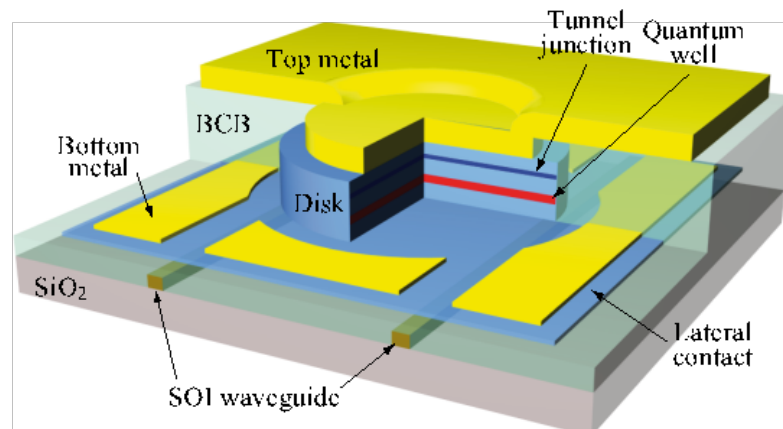

III-V integration on SOI

Hybrid / flip chip integration

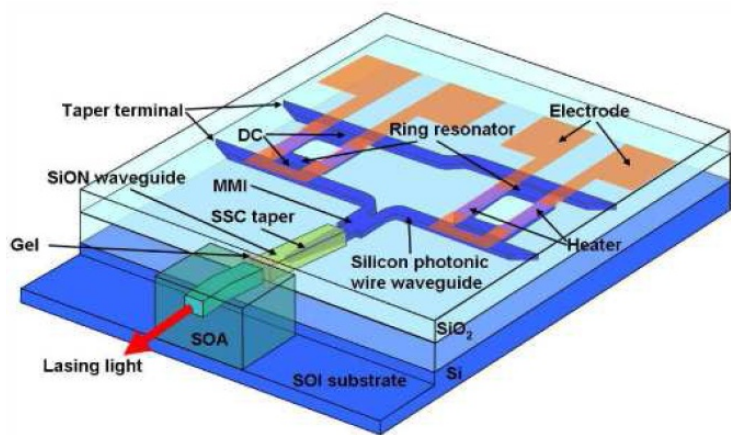

Song e.a. OE 17, 14063-14068 (2009)

III-V on Si heteroepitaxy

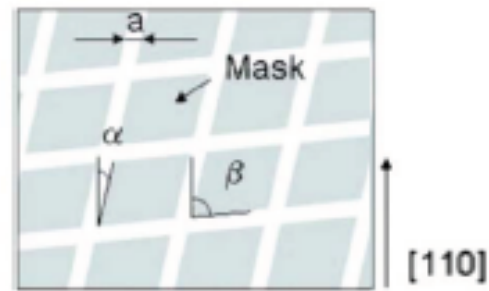

Junesand e.a., IPRM 2009 pp. 59

Wafer bonding

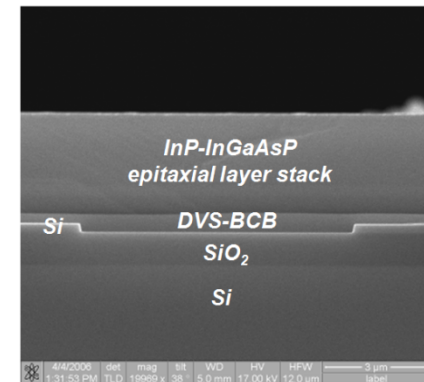

Roelkens e.a., LPR 2010

III-V integration on SOI

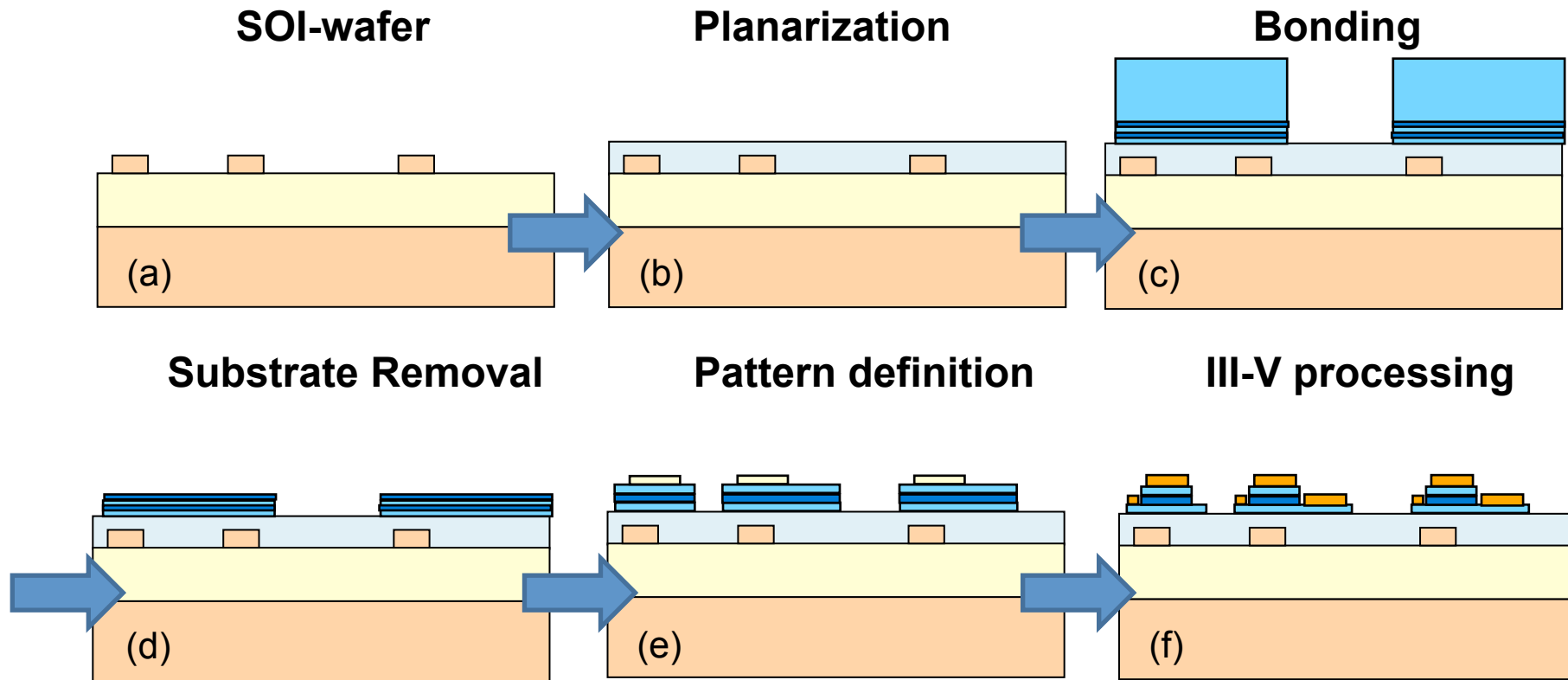

An adhesive bonding layer (DVS-BCB polymer) is used

- Large range of bonding layer thicknesses (20nm to 2 μ m)
- Requirements on wafer quality are relaxed

III-V integration on SOI

Both multiple die-to-wafer bonding and full wafer bonding (2inch)

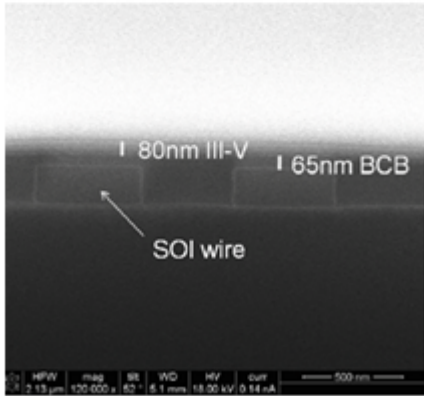
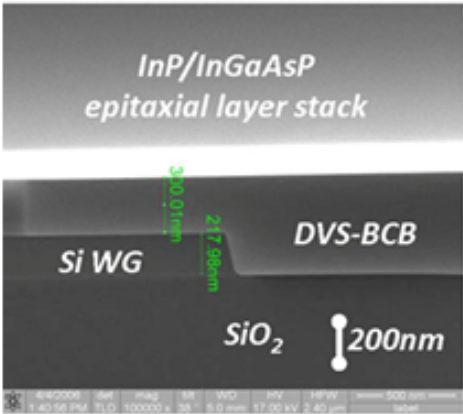
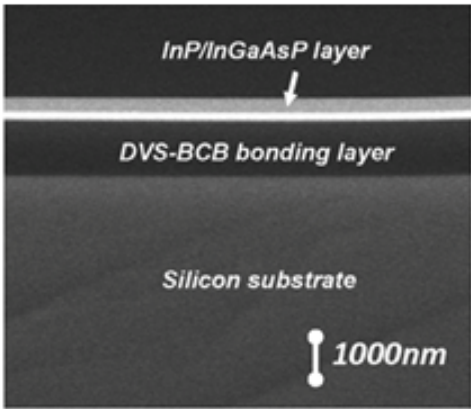
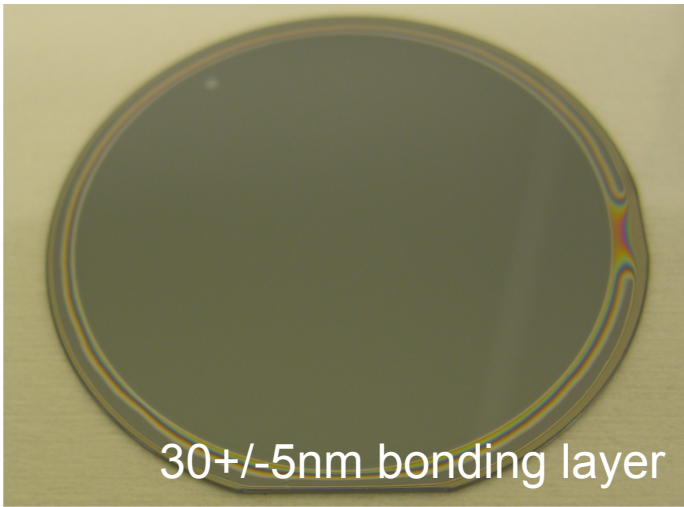
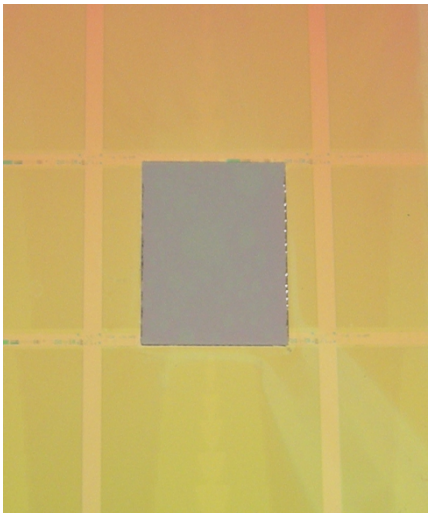
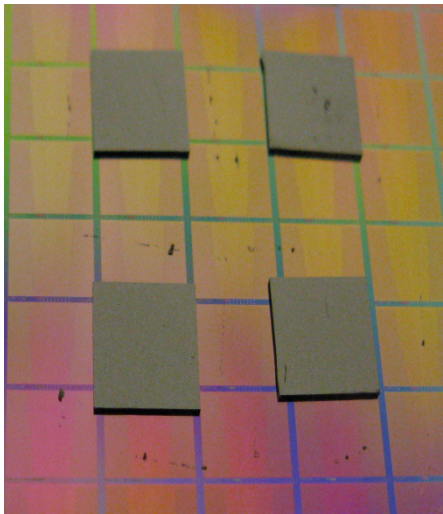

Example: III-V/Si extended cavity laser

From full confinement in III-V to full confinement in SOI

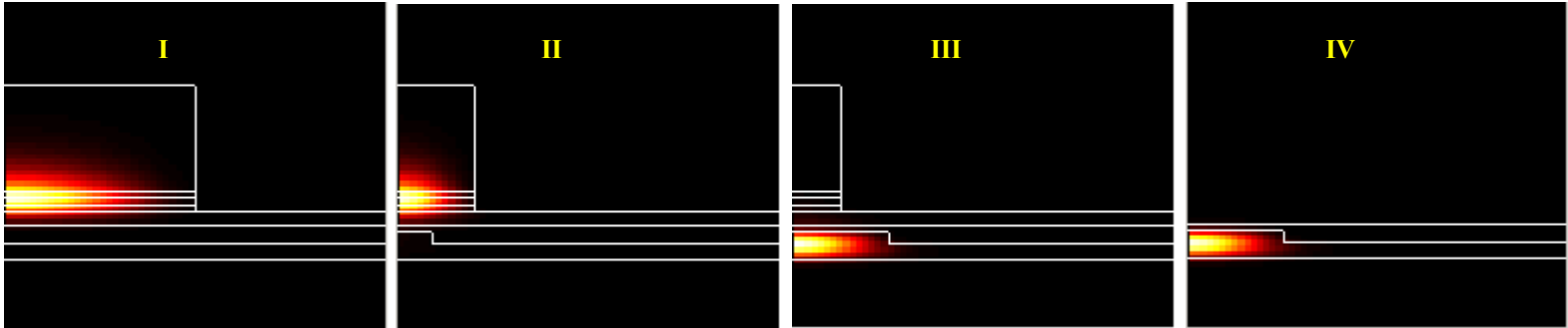
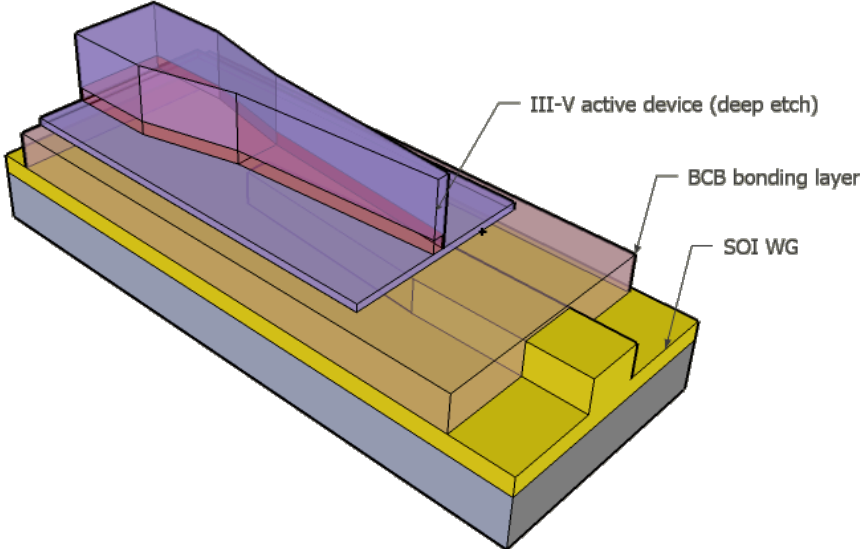

Fundamental mode in different cross-sections (BCB thickness=80nm)

Example: optical amplifier based on same technology

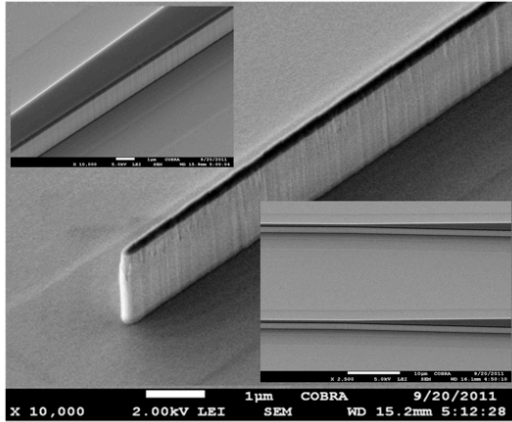
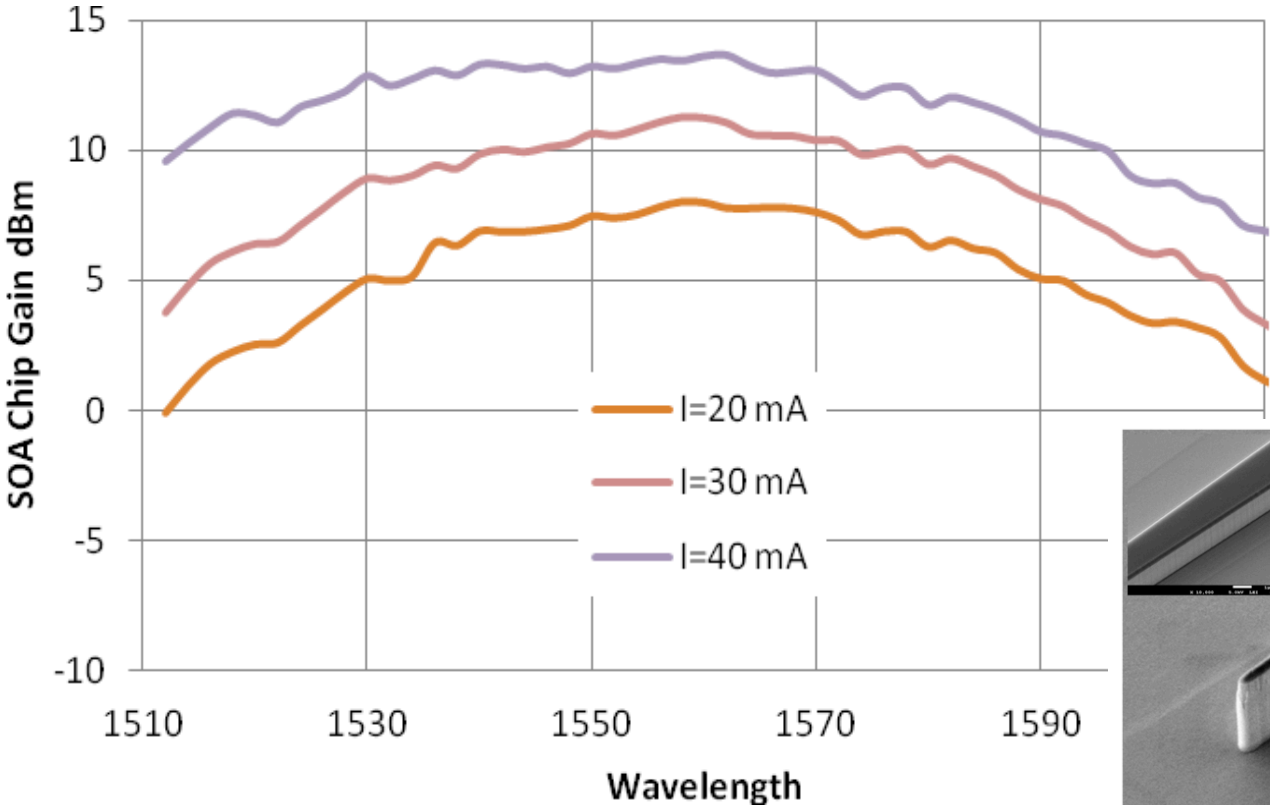
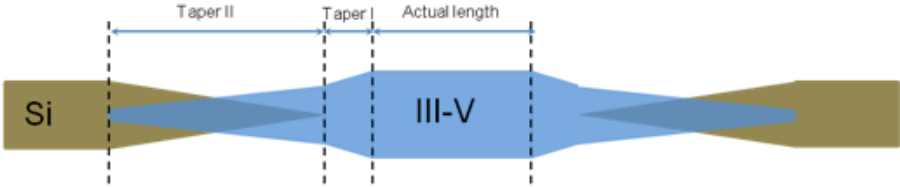

Example: integration of tunable laser with modulator

III-V/silicon tunable laser realized, co-integrated with silicon electro-optic modulator, based on ring resonator feedback

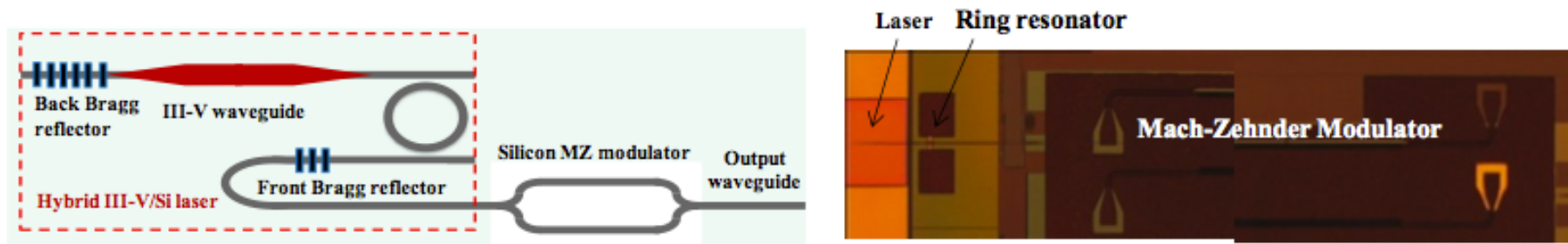
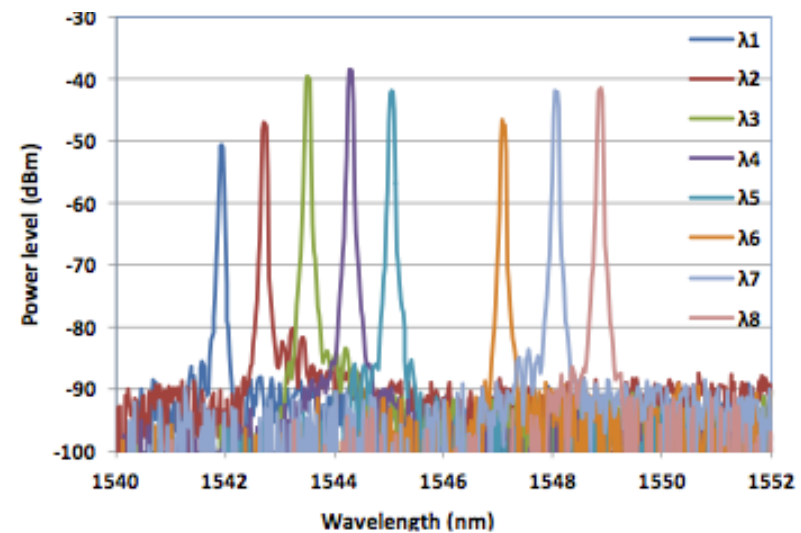
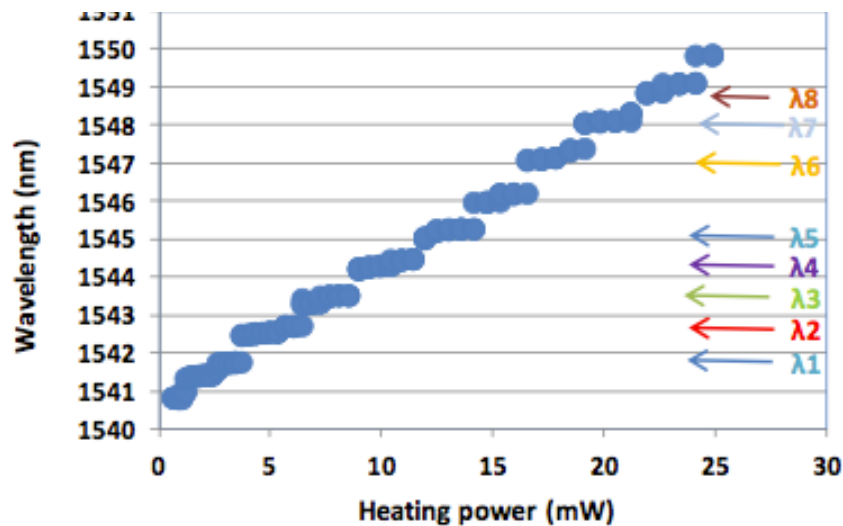
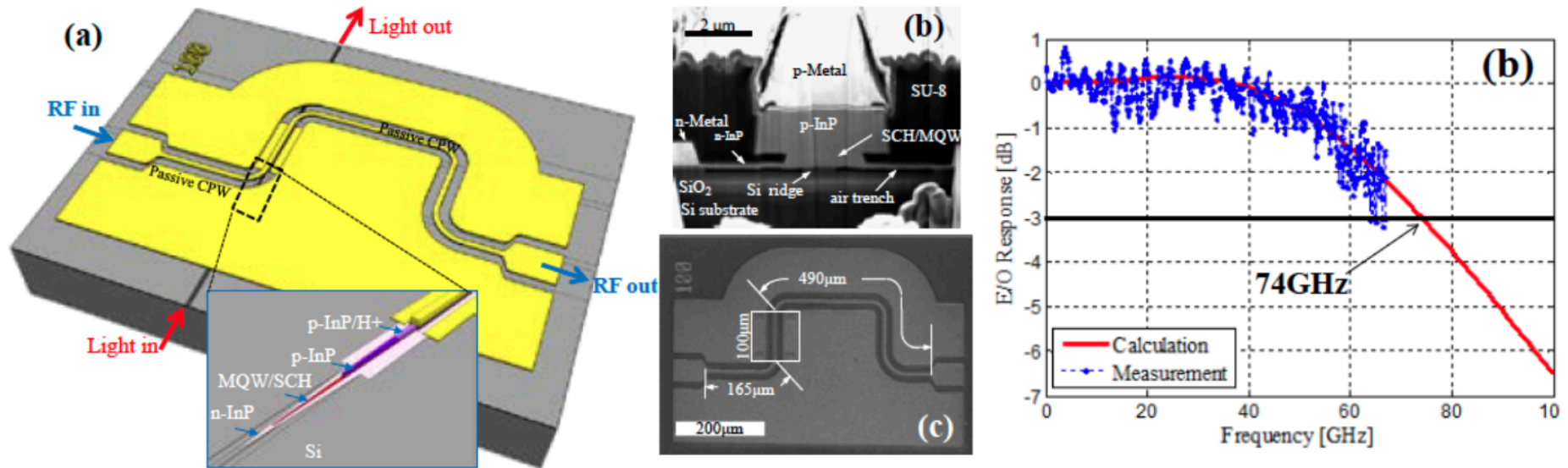

Fig. 1 Schematic view (left), and picture (right) of the ITLMZ chip



Demonstrations from other labs: hybrid EA modulators



Y. Tang, J. Peters, J. Bowers, Over 67GHz bandwidth hybrid silicon electroabsorption modulator, Opt. Expr. 20(10), p. 11529 (2012)

Outline

- Silicon photonics
- III-V/Silicon photonics
- **Electro-photonic frequency converter as case for MWP applications**

Proposed implementation

Concept of the electro-photonic frequency converter (EPFC)

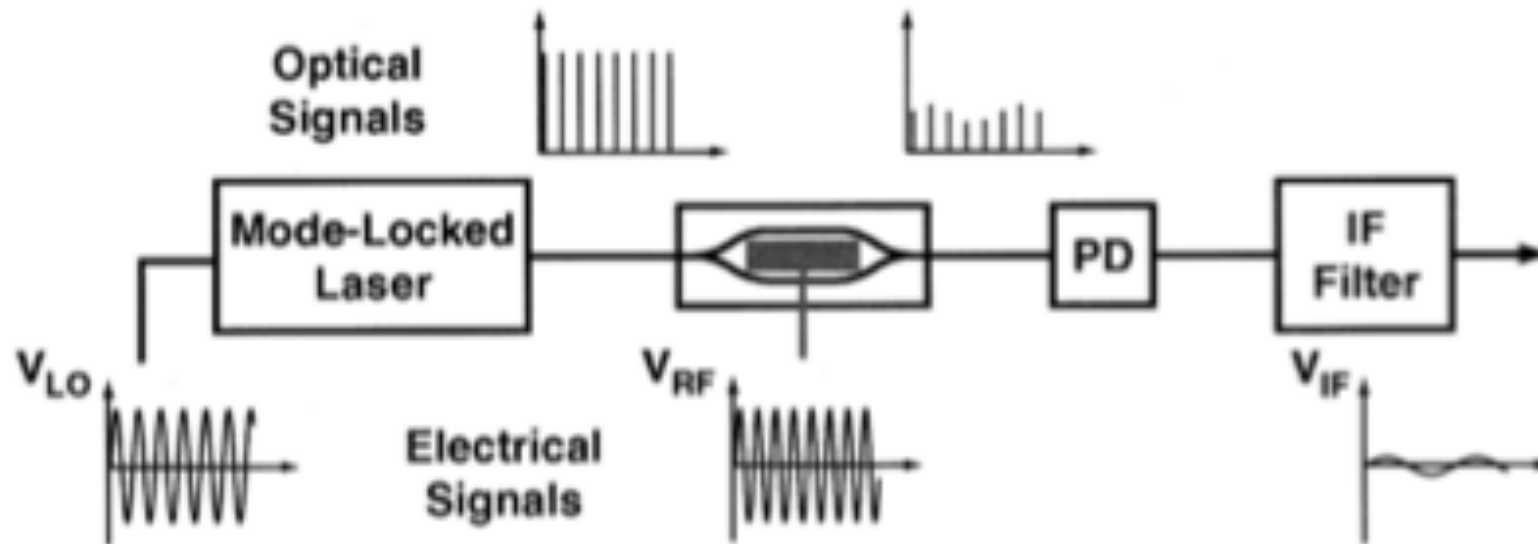

Implement functionality on III-V on silicon platform:

- III-V on silicon modelocked laser
- Silicon EO modulator or III-V EA modulator
- Silicon or III-V balanced detector pair

Proposed implementation

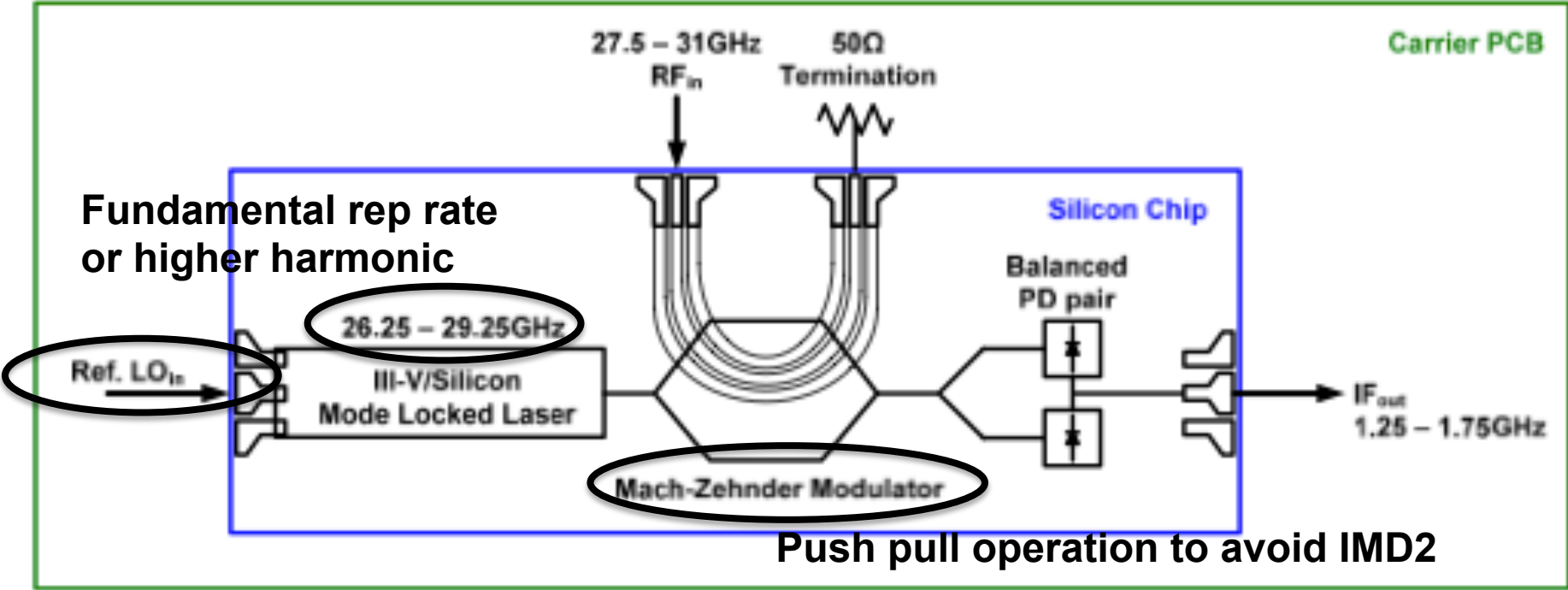

External reference necessary to reach phase-noise specs

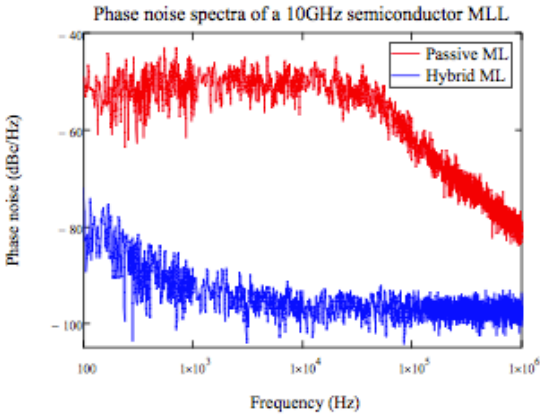

Proposed implementation: Mode-locked laser

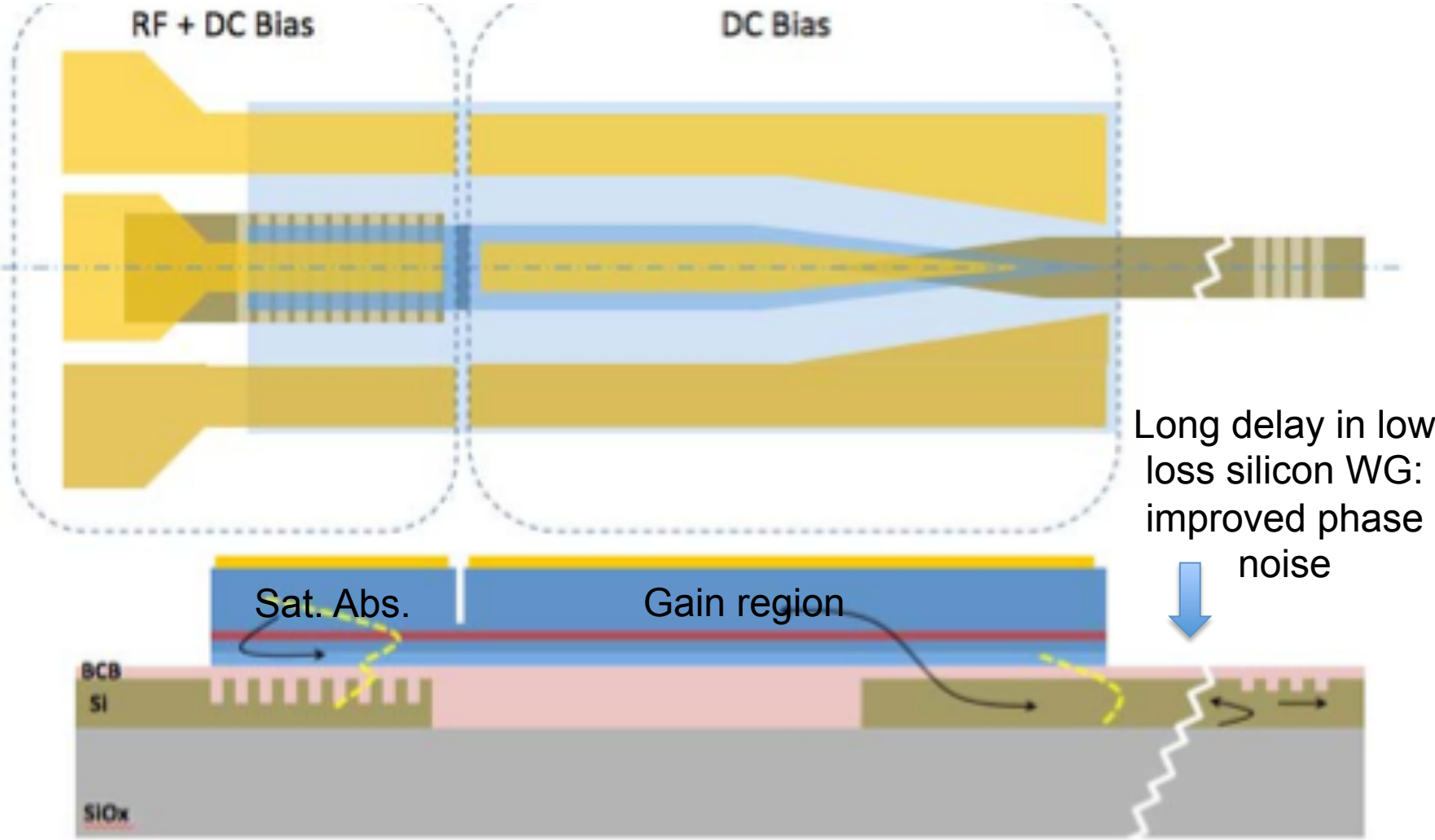

Value of integration for frequency downconverter

Electro-photonic frequency conversion allows for:

- Broad bandwidth
- Flexibility
- Re-configurability

But also increased scalability at lower mass, volume and power consumption.